

COMPONENTS

- Elastomeric PVC Body
- 316 S/S Clamps x 2
- Full Body 316 S/S Clamp Shear Band with Hose Clamps x 2

PRODUCT CODE
DUX320



FEATURES

- AS/NZS 4327 Type A accredited
- UV Stabilised
- Withstand 38°C continuous and 60° intermittent
- Capable of withstanding -40°C
- 316 Stainless Steel Hose Clamps and Shear Band
- Torque of 5.6Nm recommended
- ±5% Flex with earth movement

RELATED PRODUCTS & ACCESSORIES

- Dux Coupling Range



TECHNICAL SPECIFICATIONS

Code	A	B	C
DUX320	326 NBD* Range 310 - 342	326 NBD* Range 310 - 342	160

Coupling Spares Code	Description
DC216	316 Stainless Steel Hose Clamp

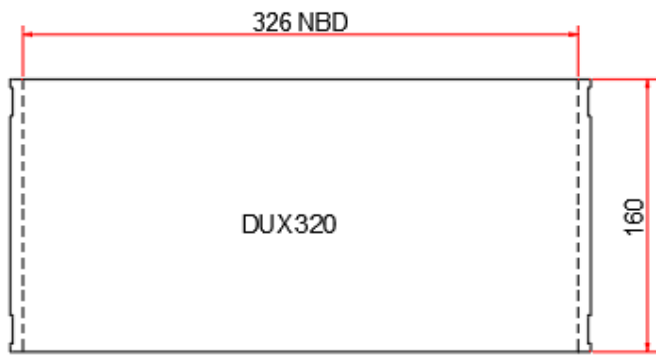
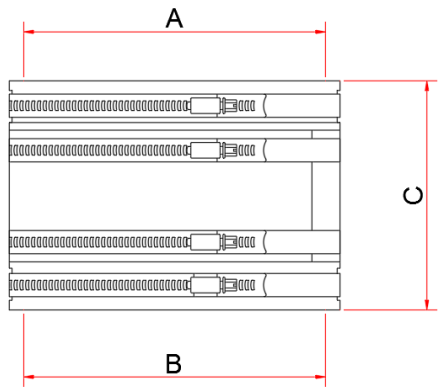

Base Coupling shown
The Elastomeric PVC is able to accommodate a range of pipe sizes due to the ability to expand or contract 5%.

NBD* - Nominal Bore Diameter, measurement is taken with coupling at rest.

All dimensions are in millimetres and subject to normal manufacturing tolerances. Dux reserves the right to vary specifications without notice.

